

# Portable wheelchar scale for medical use User Manual

MBWD-300P



## SPECIFICATION





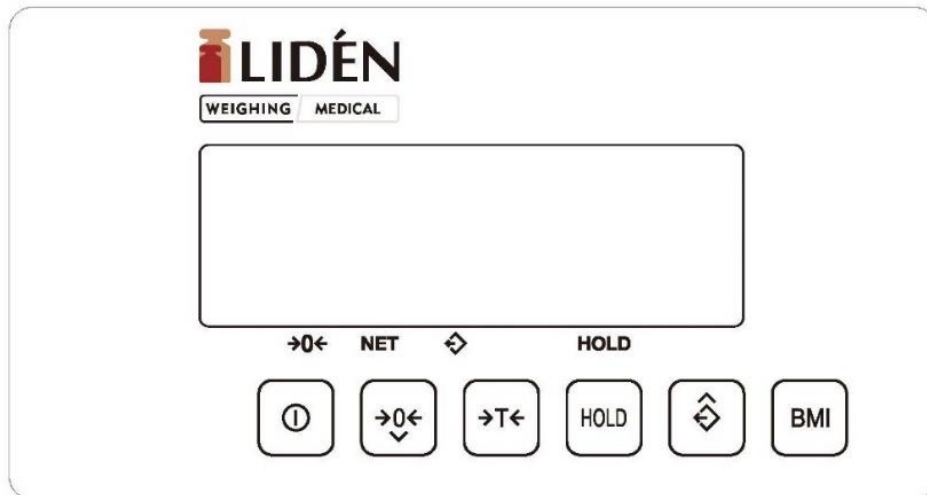

<b>Modell</b>	<b>MBWD-300</b>
Max kapacity	300 kg
Readability	100 g (0,1 Kg)
Accuracy	OIML Klass III
Tara	100 %
Min. loading	2 kg

<b>Specification</b>	
Display	25 mm heigh, 5 segment, LCD-display with background light
Construction	Steel pipe construction
Product size	1220 x 130 mm
Platforme size	920 x 130mm
Stabilization time, approx	3 Second standard
Operating temerature	0°C - 40°C / 32°F - 104°F
Power supply	7,5V/1A AC adapter and 6xAA Battery
EU-verified in accordance with 2014/31 / EU	Klass III
MDD approved in accordance with 93/42/EEC	Klass I

## Keypad



## Keypad funtion

-  Power On/Off
-  Zero key
-  Tare key
-  Hold key
-  Recall last data
-  BMI

## Symbols



Zero mode on



Net display / Scale is tared in position



Recalled value



Lock (hold) mode



Stable mode on

## Operation & Key functions



On/Off

Press briefly to switch the scale on and off.



Recet button

Resets the scale display. Used for unloaded scales.

 indicated.



Tare key

The tare button is used to tare things that are weighed together with the patient (eg clothes, shoes or other). Do this: place a weight (clothes, shoes or other) on the scale. Press  to remove this weight. The display will show **NET**.

Remove (clothes, shoes or other) and press  to exit tare function.





Manual or automatic hold function





In zero mode, you can use the manual or automatic hold function by pressing  the display shows **Hold Auto** eller **Hold Off**.

**Manual hold:** Stand on the scale. Wait for the stable value, then press  to lock the value.

The display returns to zero after about one second. The value is retrieved by pressing  Cancel.

**Automatic Hold:** Set Hold Auto as above by pressing  Stand on the scale. At stable weight, the scale will automatically lock the value. If the weight after locking changes more than 4 kg, the scale is activated again and, when the scale is stable, will again automatically lock the value.

 BMI – Body Mass Index

1. Put a person on the scales and wait until the scales are stable.
2. Press  and then use  or  to set the persons height. Then press again on  to exit and view the calculated BMI.
3. The BMI value disappears when the person leaves the scale but can be recalled with .

### Replacing batteries:

1. Disconnect the power supply to the scale.
2. Remove the battery cover on the back of the indicator. Insert 6 pcs. new AA batteries and make sure the poles are seated correctly.
4. Close the battery cover.

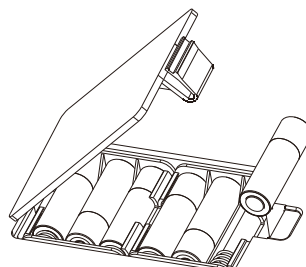
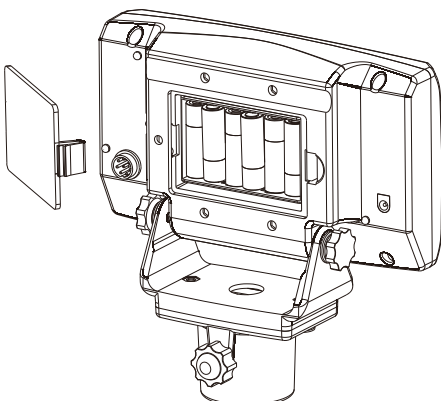

**NOTE!** Do **not** use rechargeable batteries. If you do, the batteries should be charged in an external charger. The scale adapter cannot charge the batteries when they are in the scale.

## **Cleaning.**

### Cleaning / Disinfection

During all maintenance work with the chair scale, the power supply must be cut off.

The chair with seat and backrest may only be cleaned with household cleaners or disinfectants, e.g. 70% isopropanol solution.

We recommend a disinfectant that is intended for disinfection by wet drying the surfaces of the chair scale.

There, follow the manufacturer's instructions.

Do not use polishes or aggressive cleaners such as alcohol, gasoline or anything else, as they can damage the surfaces that are made of plastic or rubber.

### **Keep in mind that:**

When you move the scale, the cable must be removed and reassembled. Please pay attention to how the cable will be reassembled.